

VELIS 57x37 TRASLATO

CATALANO
THE ESSENCE OF CERAMICS

cod. 1VPT5700

Wc scarico a parete trasformabile a terra tramite curva tecnica.

Wc with horizontal outlet convertible to flooroutlet by a pipe fitting.

WC mit Wandabfluss, durch Kurventechnik auf Bodenabfluss umrüstbar.

cod. 5CAWC00

Raccordo di alimentazione regolabile
adjustable pipe fitting

cod. Z542386

Fissaggio a parete.
wall fixing elements

cod. 5V57STF000

Sedile soft-close in resina inalterabile.

Soft-close Seat-cover made of unalterable resin.

WC-Sitz SoftClose aus beständigem Harz.



CE EN 997 - CL1 - 5A

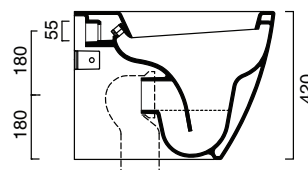
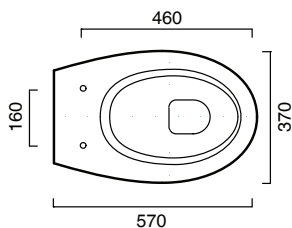

Fissaggio a parete
how to install the toilet.

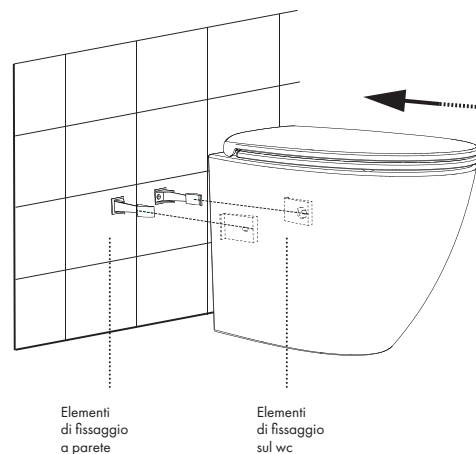

Regolazioni dei kit di alimentazione e scarico
adjustments for inlet and outlet pipes.

Curva tecnica fissa - Standard pipe elbow fitting
Cod. 5CUIG00

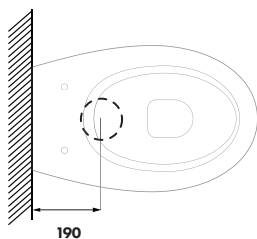

Raccordo di alimentazione regol - Adjustable pipe fitting
Cod. 5CAWC00

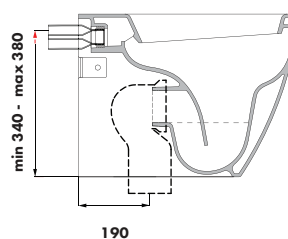

Curva tecnica regolabile - Adjustable pipe elbow fitting
Cod. 5CU0400

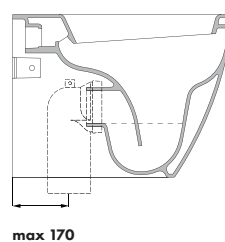
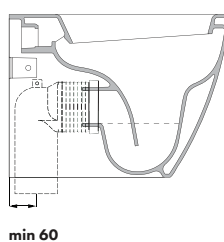
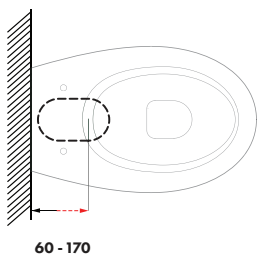

Curva tecnica regolabile - Adjustable pipe elbow fitting
Cod. 5CU0300

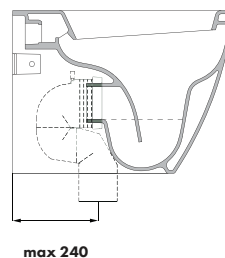
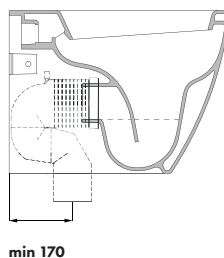
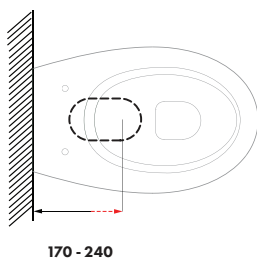

MADE IN ITALY

CATAglaze

È una barriera totale a prova di sporco. Creando una superficie liscia e planare, elimina i micro avvallamenti della ceramica, evitando per sempre alle macchie di aderire.

Is a total bacteria-proof barrier. By creating a perfectly smooth and flat surface, it eliminates the micro-depressions of ceramics and does not allow dirt to stick on it anymore.

Cataglaze bildet eine schmutzabweisende Barriere. Dank der perfekt glatten und ebenen Oberfläche werden Vertiefungen in der Keramik beseitigt und dadurch das Anhaften von Schmutz und Kalk deutlich reduziert.

GARANZIA

Il rivenditore sostituirà i prodotti con difetti di fabbricazione entro due anni dalla consegna.

Your retailer will replace products with faults of manufacturing within two years from delivery date.

Der Wiederverkäufer wird Produkte mit Fabrikationsfehlern innerhalb 2 Jahren seit Zustellung ersetzen.

PULIZIA

Si consiglia di pulire con acqua tiepida e detersivo non abrasivo.

The maintenance has to be done with tepid water and not abrasive detergents.

Für die Reinigung empfiehlt sich lauwarmes Wasser und keine Scheuermittel zu verwenden.

DICHIARAZIONE DI PERFORMANCE - DOP N° 997

Scarica il documento al seguente link a lato:

Click the link on the side to download the document:

Klicken Sie auf den Link zum Herunterladen des Dokuments:

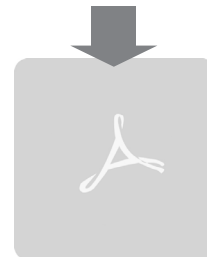

WATER LABEL

Una nuova etichetta informativa accompagna i WC Catalano, attribuita e certificata dalla The Water Label Company. L'etichetta mostra una classificazione di performance, indicando il volume massimo d'acqua che il wc utilizza nella fase di scarico.

All Catalano WCs have a new label, certified and issued by The Water Label Company. The label shows a performance ranking, indicating the maximum water volume of the toilet's flush.

Die Catalano-WCs besitzen eine neue Zertifizierung, die von der Water Label Company vergeben wird. Die Zertifizierung stellt eine Leistungsklassifizierung dar und gibt das maximale Wasservolumen an, das ein WC bei der Spülung verbraucht.

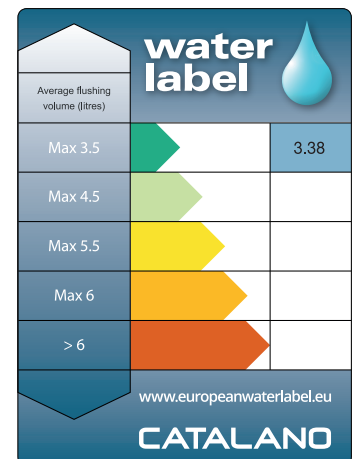

KIT DI FISSAGGIO

vedi il video al seguente link a lato:

Click the picture on the right to watch the video:

Klicke auf das Bild rechts, um das Video anzuschauen:

